

BOTTOM VIEW

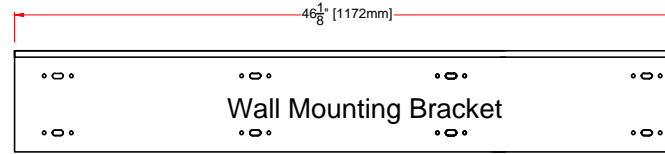

Wall Mounting Bracket

Wall mount can be fixed directly to wall, or may be secured to the extension brackets provided if the Barrier must extend off the wall.

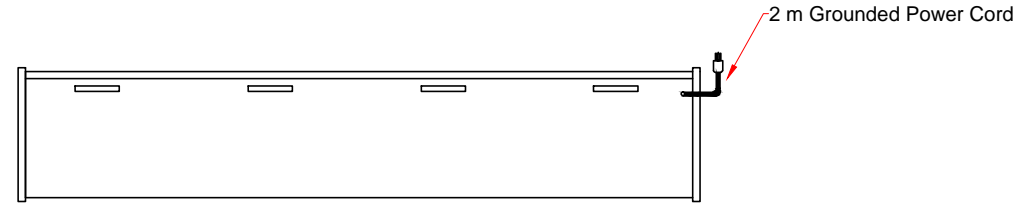
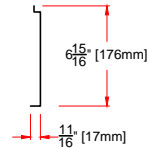

BACK VIEW

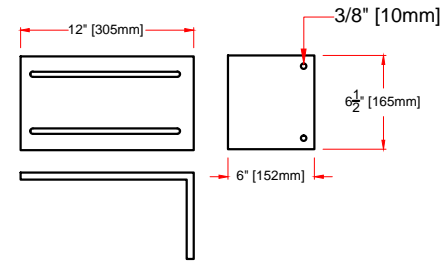

EXTENSION BRACKET 2 PER UNIT
See Owners Manual for Details

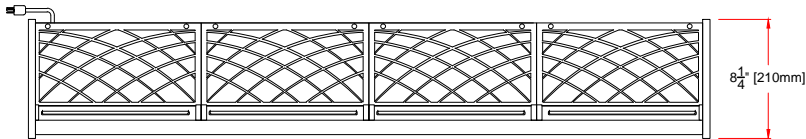

TOP VIEW

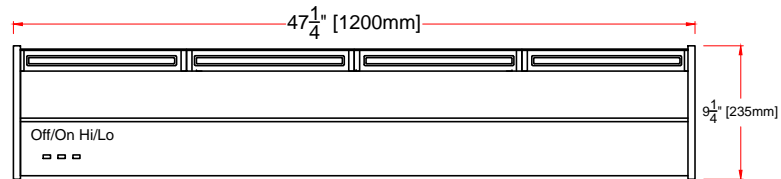

FRONT VIEW

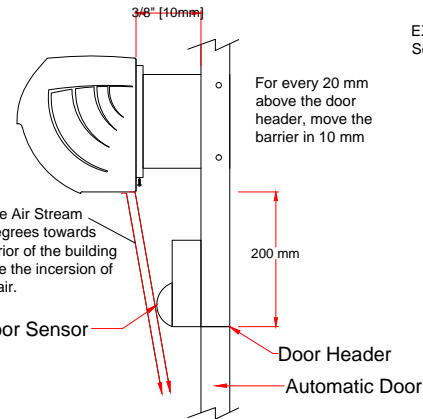

EXTENSION BRACKET 2 PER UNIT
See Owners Manual for Details

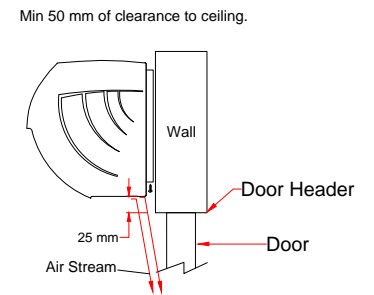

CE Certified

ENERSHIELD EUROPE
Calderhead Road
Shotts Lanarkshire Scotland
Tel.+44(0)1501 826501 FAX+44(0)1501 826501
E-mail: enquiries@enershield.eu
www.enershield.eu

AVAILABLE IN WHITE, BLACK AND ALUMINUM FINISH

VOLTAGE 223V/1/50 Hz
2 Speed Motors TEAO
2 @ 0.15 kW = (0.30 kW total)
Total FLA = 3.5 amps
Designed for optimal efficiency at 2133mm with balanced building pressure. Consult dealer for varying applications.
Remote operable

Project:
Engineer:
Tag:

MICROSHIELD

Air Velocity Hi/Low (fpm) (m/s)
Air Volume Hi/Low (cfm) (l/s)
Total kW/watts
Weight lbs/Kg

MCS-48

3150-2560/16-13
882-706/416-334
0.30/298W
39.6 lbs/18 Kg